

# POWER TRANSISTOR CLAMP DEPRESSOR

Hankook Fastener

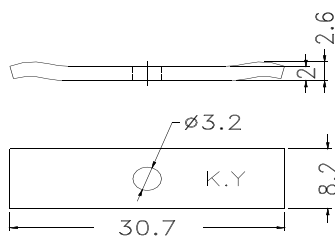
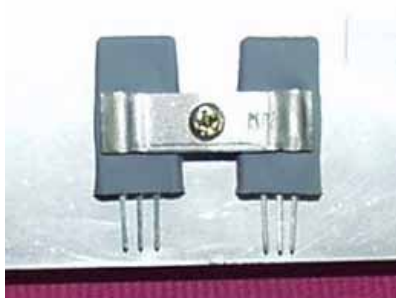

◆ MATERIAL: STEEL

◆ UNIT: mm

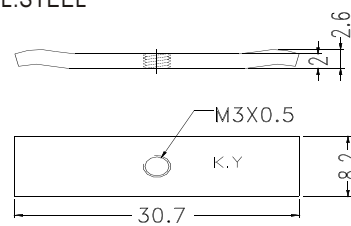

PART NO	PACKAGE
TRK-8	1000

PART NO	PACKAGE
TRK-9	1000

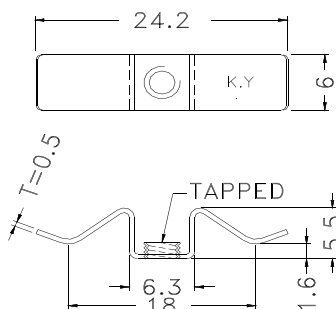
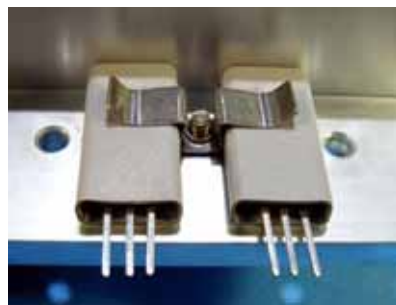

PART NO	TAPPED	PACKAGE
TRK-10	M3X0.5	1000
TRK-10(M4)	M4X0.8	
★TRK-10(632)	6-32 UNC	



◆ MATERIAL: ZINC PLATED SPCC

◆ UNIT: mm

PART NO	PACKAGE
TRK-11	1000

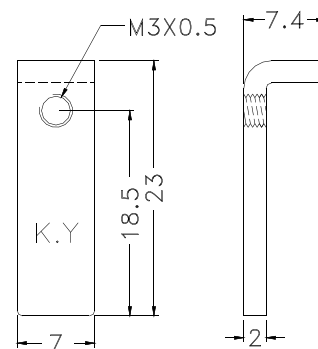

# PLASTIC GEAR

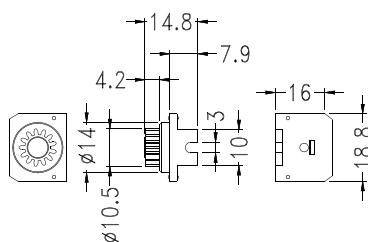

MODULE	0.7
PITCH CIRCLE DIAMETER	∅ 9.1
TOOTH NUMBER	13
PRESSURE ANGLE	20°

PART NO	PACKAGE
DP002A	500

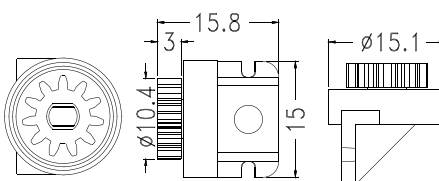

MODULE	0.8
PITCH CIRCLE DIAMETER	∅ 8.8
TOOTH NUMBER	11
PRESSURE ANGLE	20°

PART NO	PACKAGE
DP003A	500

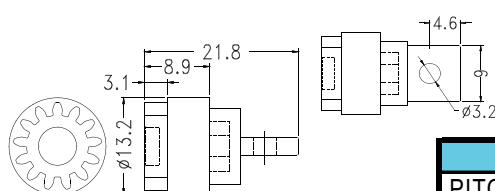

PART NO	PACKAGE
DP004A	500

MODULE	0.8
PITCH CIRCLE DIAMETER	∅ 10.4
TOOTH NUMBER	13
PRESSURE ANGLE	20°

- ◆ GEAR MATERIAL:P.O.M(UL)94HB
- ◆ BODY MATERIAL:A.B.S(UL)94HB
- ◆ COLOR:BLACK
- ◆ UNIT:mm

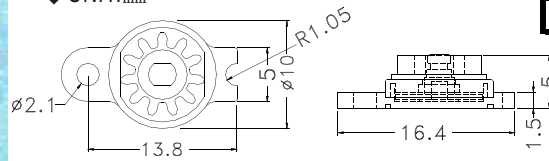

MODULE	0.6
PITCH CIRCLE DIAMETER	∅ 6.6
TOOTH NUMBER	11
PRESSURE ANGLE	20°

PART NO	PACKAGE
DP006A	500

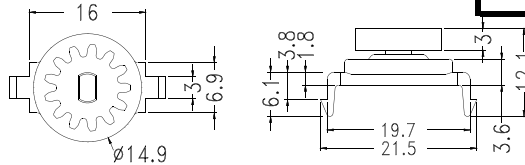

MODULE	0.8
PITCH CIRCLE DIAMETER	∅ 10.4
TOOTH NUMBER	13
PRESSURE ANGLE	20°

PART NO	PACKAGE
DP007A	500

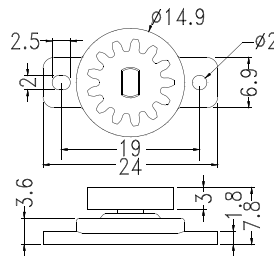

MODULE	0.8
PITCH CIRCLE DIAMETER	∅ 10.4
TOOTH NUMBER	13
PRESSURE ANGLE	20°

PART NO	PACKAGE
DP008A	500

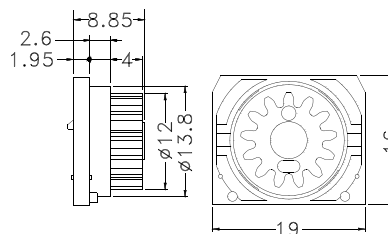

MODULE	0.8
PITCH CIRCLE DIAMETER	∅ 10.4
TOOTH NUMBER	13
PRESSURE ANGLE	20°

PART NO	PACKAGE
DP009A	500